

## Verona 5 Drawer Tall Chest Wall Attachment Instructions

### Pre-assembly Preparation

**Please read** these instructions fully prior to assembly to familiarise yourself with the various stages of construction. Carefully open all packs supplied and check the contents against the parts and fittings check list.

Do not destroy any of the packaging until you are certain that you have all the necessary parts for the assembly.

This product is **HEAVY**, it should be assembled as near as possible to the point of use.

**Take care when lifting** to avoid personal injury and (or) damage to the product.

There are small components used in the construction of this furniture as well as plastic foil packaging, these should be kept away from young children whilst assembling.

This product requires a minimum of 2 people to assemble.

### Product Safety

All assembly fastenings should always be tightened properly and care should be taken to ensure that no fittings are loose.

Periodically check and ensure that all components are in their proper position, free from damage, and that all connectors are tight.

### Product Care

To clean, slightly moisten cloth with water and wipe surfaces. A damp cloth holds dust and prevents damage. repeat with a dry, soft, lint-free cloth.

Do not use abrasives or cleaning products which may contain ammonia or solvents

### Tools Required:

Please use a Phillips Screwdriver (not included)



# Verona 5 Drawer Tall Chest Wall Attachment Instructions

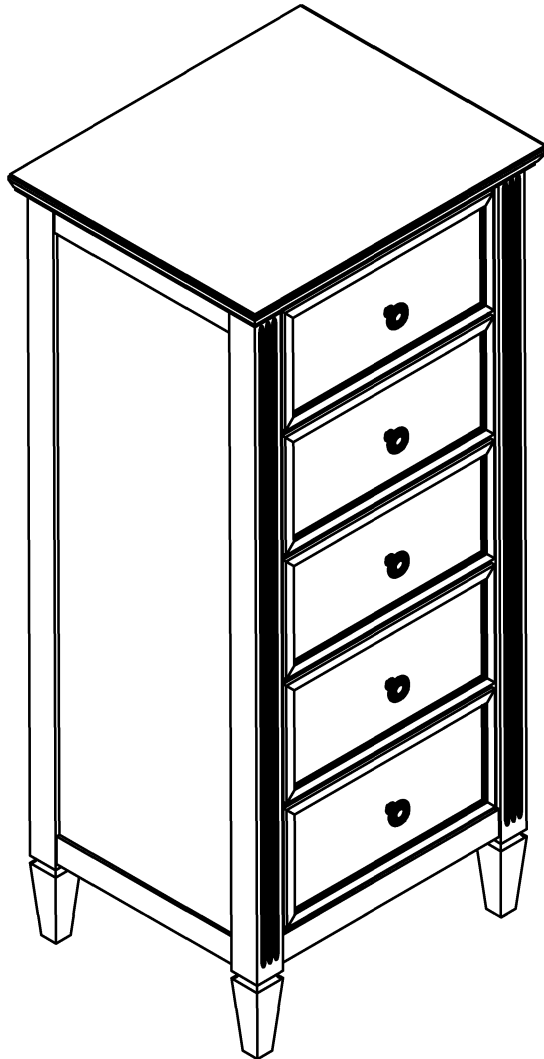

## Hardware and Wall Fixing Packs

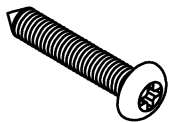

Strap Fixing Screw

**(A) = 1 pc**



Strap Fixing Washer

**(B) = 1 pc**



Strap

**(C) = 1 pc**

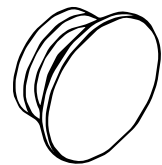

Optional Painted Handle

**5 pcs**

# Verona 5 Drawer Tall Chest Wall Attachment Instructions

1

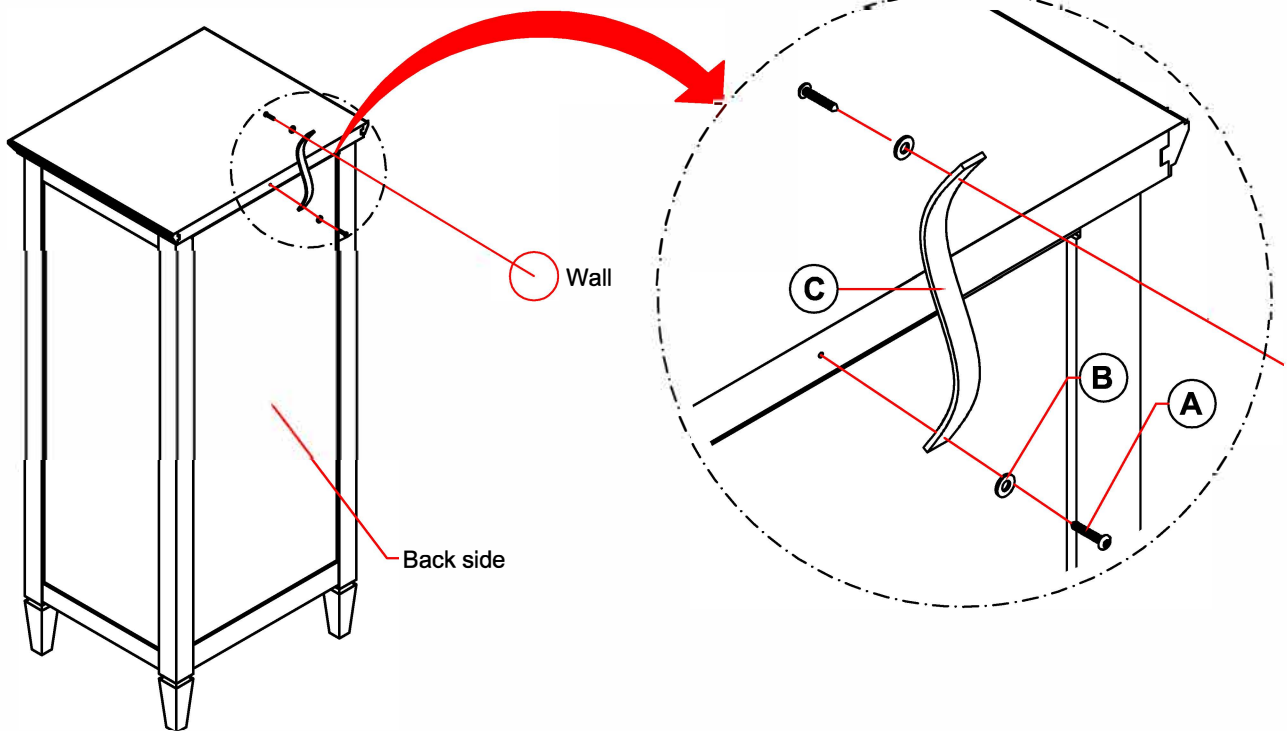

To avoid any risk of tipping, it is recommended to secure this unit to the wall as below instruction guide  
Due to different wall types, fixing NOT included

Wall Fixing - if in doubt seek professional advice

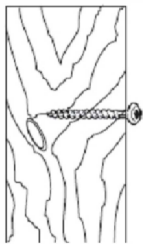

## Wood

If fixing to wood make sure that it isn't chipboard as screws can easily pull away from the core structure

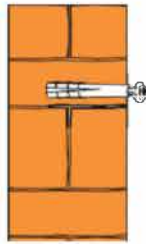

## Brick or Masonry

Use an appropriate wall plug provided you are sure your wall is sound

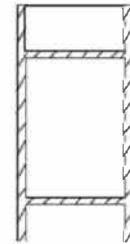

## Cavity Wall

Special toggle wall plugs are needed. Seek expert advice